



ABBOTSHOLME

AN EDUCATION FOR LIFE

Abbotsholme School

Year 7 Entrance Exam Maths paper

Name: _____

Time allowed: **1 hour**

Answer **ALL** questions on the sheet.

Show your working clearly.

Calculators are **NOT** allowed.



Raw score		Percentage	%
------------------	--	-------------------	----------

1. Placing fractions

Here are four fractions.

$$\frac{3}{4}$$

$$\frac{1}{8}$$

$$\frac{1}{3}$$

$$\frac{3}{5}$$

Look at the number line below.

Write each fraction in the correct box.

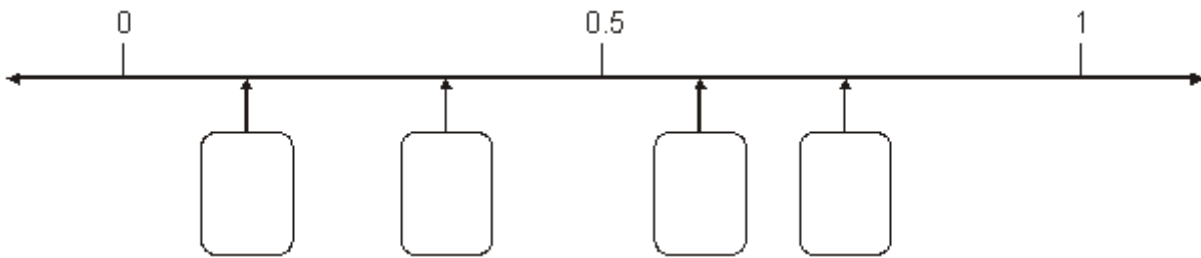

2 marks

2. True or false

Look at the number sentences below.

Tick (✓) ones that are correct and cross (✗) ones that are incorrect.

	✓ or ✗
$5 + 8 = 8 + 5$	
$5 - 8 = 8 - 5$	
$5 \times 8 = 8 \times 5$	
$5 \div 8 = 8 \div 5$	

2 marks

3. Dial

Look at the dial.

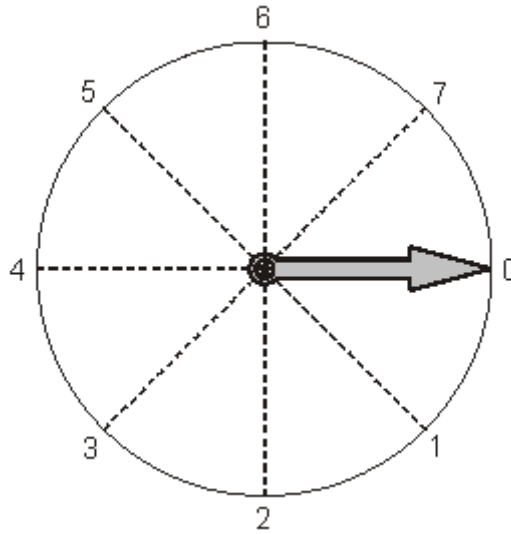

The pointer starts at 0 and turns **clockwise** around the centre.

(a) Which number does it point to after turning clockwise through **90°**?

.....

1 mark

(b) The pointer turns clockwise from **3 to 6**

Through how many degrees does it turn?

.....°

1 mark

4. Travel

Jamie travels by car for 2 hours, then by train for 3.5 hours. For how many **minutes** has he travelled?

.....

2 marks

5. **Rectangle**

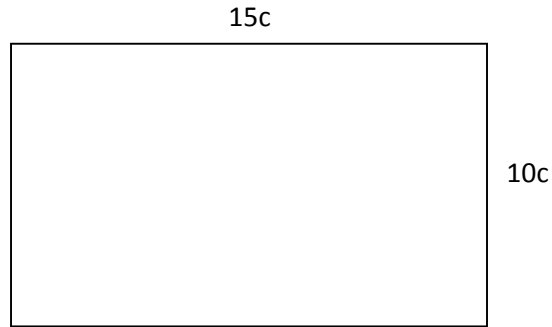

Not drawn accurately

What is the **perimeter** of the rectangle above?

.....

2 marks

6. **Eight times**

Write the missing numbers in the boxes.

$$8 \times \boxed{} = 800$$

1 mark

$$0.8 \times \boxed{} = 8$$

1 mark

7. **Fractions**

Calculate

$$\frac{5}{8} \times \frac{3}{5}$$

Show your working. Write your answer as a fraction in its **simplest form**.

.....

1 mark

8. Odds and evens

(a) Anna says:

Multiply any number by three.

The answer **must** be an **odd** number.

Give an example to show that Anna is **wrong**.

1 mark

(b) Jay says:

Divide any **even** number by two.

The answer **must** be an **odd** number.

Give an example to show that Jay is **wrong**.

1 mark

9. Boxes

Boxes of tins are delivered to a shop.

There are **37 boxes**.

Each box contains **25 tins**.

How many tins are there?

.....

2 marks

10. Cubes in bags

I have two bags of cubes.
Each bag contains more than 20 but fewer than 30 cubes.

- (a) I can **share** the cubes in bag A **equally between 9** people.
How many cubes are in bag A?

.....

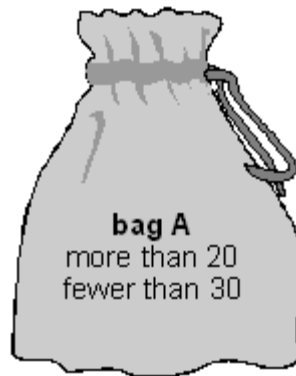

1 mark

- (b) I can **share** the cubes in bag B **equally between 4** people.
How many cubes could be in bag B?
There are two answers. Write them both.

..... or

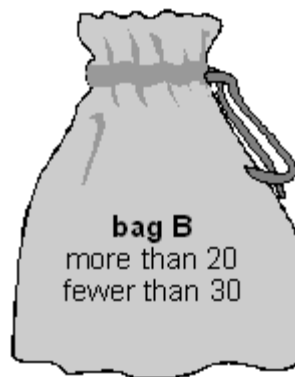

2 marks

11. Calculations

Work out the following. Show your working clearly.

65×9

.....

1 mark

$154 \div 7$

.....

1 mark

12. Radio

Two websites sell the same type of radio.

	Website A	Website B
Cost of radio	£ 79.99	£ 76.76
Cost of postage	£ 3.49	£ 6.79

Sunil is going to buy the radio from one of the websites.

He also has to pay for postage.

Which website is **cheaper**? You **MUST** show your working.

Website

3 marks

13. Brackets

(a) Work out the answer.

$$2 + (16 \div 2) + 6 = \dots\dots\dots$$

1 mark

(b) Put brackets in the calculation below to make it correct.

$$2 + 16 \div 2 + 6 = 4$$

1 mark

14. Add to 8

Complete this diagram so that the three numbers in each line **add to 8**

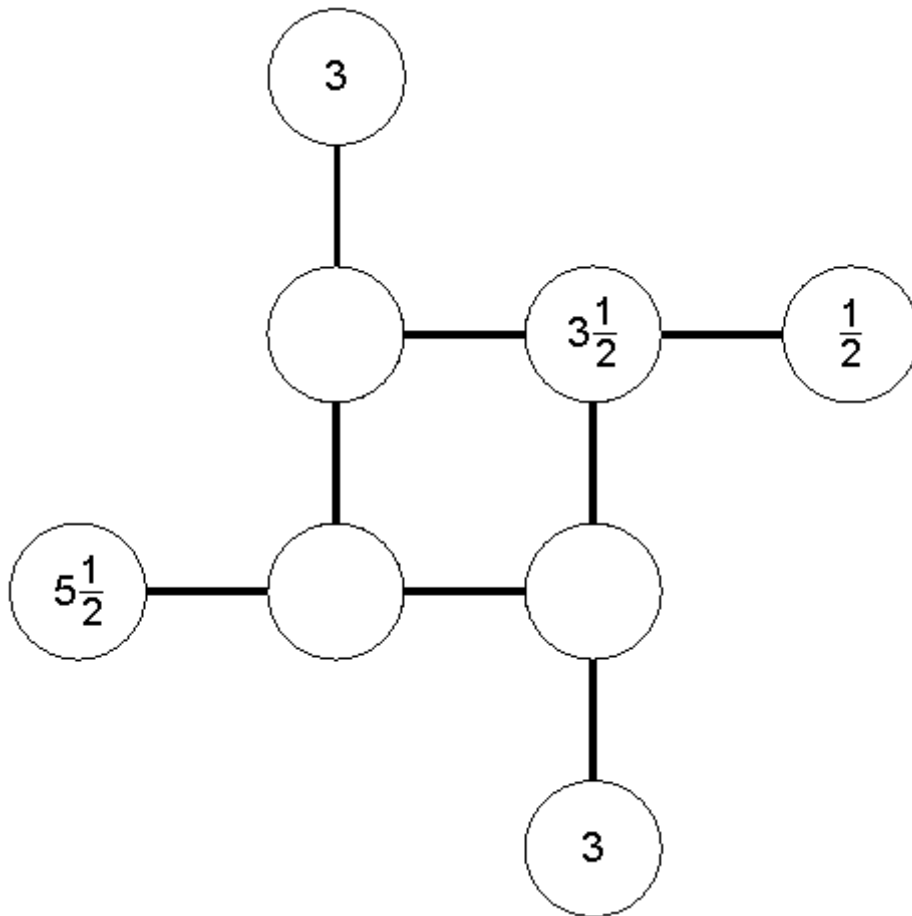

3 marks

15. Dividing fractions

Work out the following: You MUST show your working.

$$\frac{3}{4} \div \frac{1}{8}$$

.....
3 marks

16. Cards for fractions

Here are six number cards.

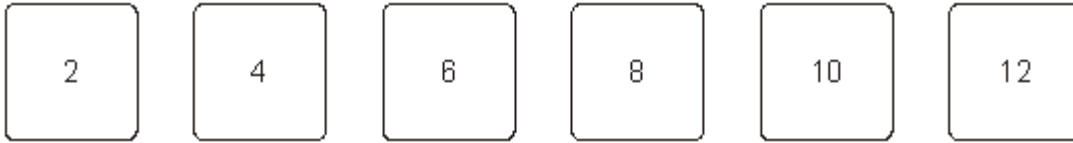

- (a) Choose two of these six cards to make a fraction that is equivalent to $\frac{1}{3}$

$$\frac{\boxed{}}{\boxed{}}$$

1 mark

- (b) Choose two of these six cards to
make a fraction that is **greater than** $\frac{1}{2}$ but **less than 1**

$$\frac{\boxed{}}{\boxed{}}$$

1 mark

17. Angles

Work out the sizes of angles a , b and c in the triangles below.

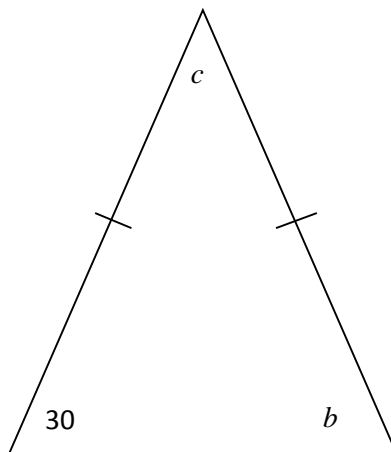
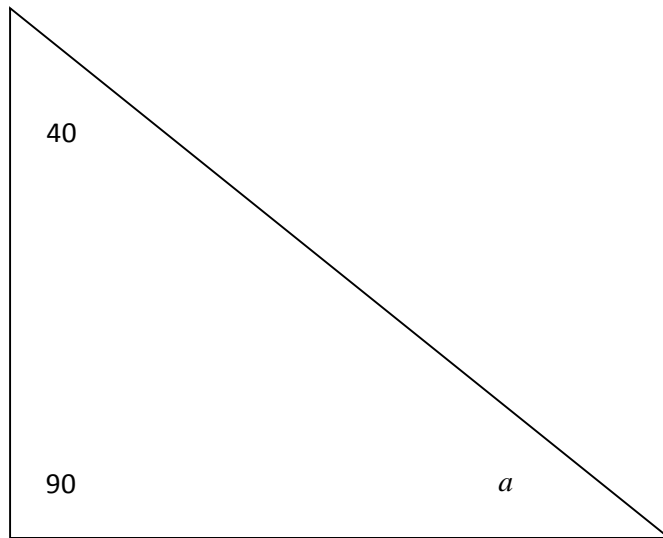

$a = \dots\dots\dots^\circ$ $b = \dots\dots\dots^\circ$ $c = \dots\dots\dots^\circ$

3 marks

18. Shopping

Some people in a supermarket are shopping for food.

- (a) **100g** of cheese costs **46p**.

Peter buys **400g** of the cheese.

How much does he pay?

£

1 mark

- (b) Tins of beans cost **36p each**.

What is the largest number of these tins John can buy with **£2**?

.....

1 mark

19. Sleep

Some people use this rule to work out how many hours' sleep each night young children need.

Subtract the child's age in years from 30 , then divide the result by 2
--

- (a) Sanjay is **8** years old.

Use the rule to work out how many hours' sleep he needs.

..... hours

1 mark

- (b) Lisa is **6** years old. She wakes up every morning at **7am**.

Use the rule to work out what time she needs to go to sleep.

..... 2 marks

20. TV Channels

The chart shows the popularity of different television channels.

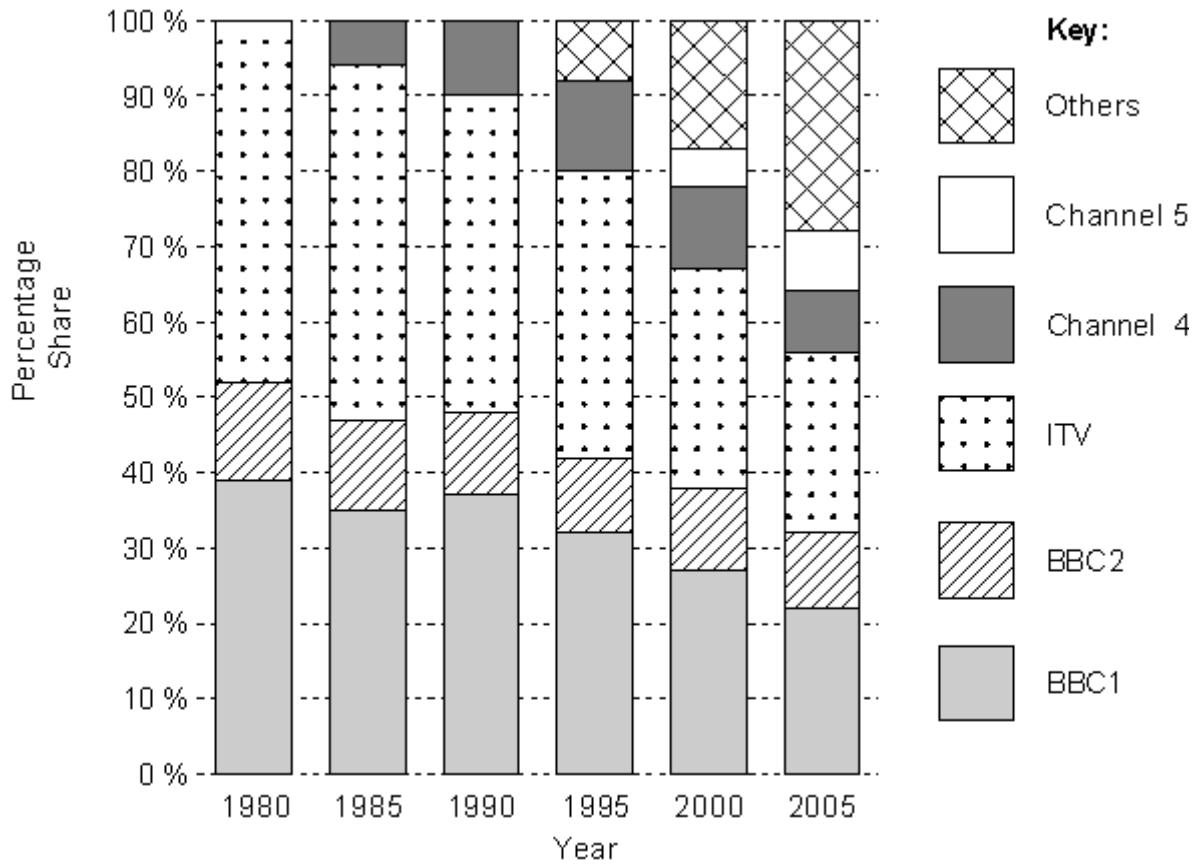

Complete the missing information.

In **1980**, only three television channels were available. The most popular was

1 mark

In **2005**, the biggest percentage share is for

1 mark

The percentage share for remained **almost the same** at about % each year.

1 mark

21. Perimeter and area

Look at the hexagon and the triangle.

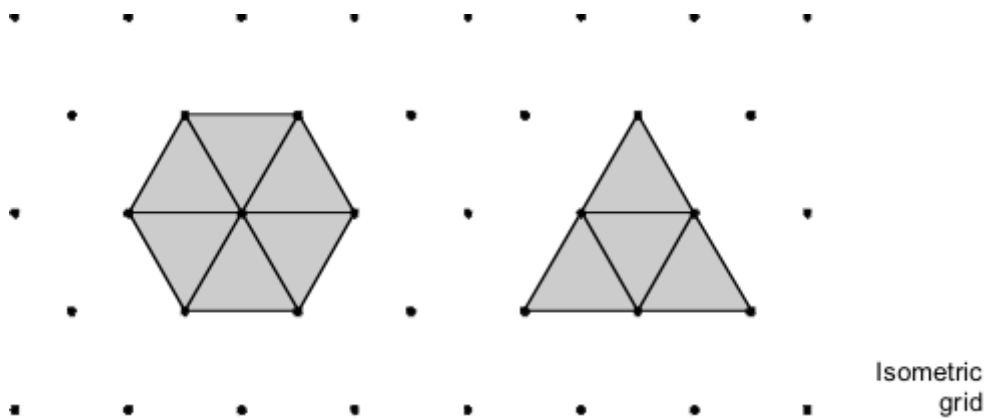

- (a) Do the hexagon and triangle have the **same area**?
Tick (✓) Yes or No.

Yes No

Explain your answer.

1 mark

- (b) Do the hexagon and triangle have the **same perimeter**?
Tick (✓) Yes or No.

Yes No

Explain your answer.

1 mark

22. Shape statements

Look at the shaded shape drawn on the square grid.

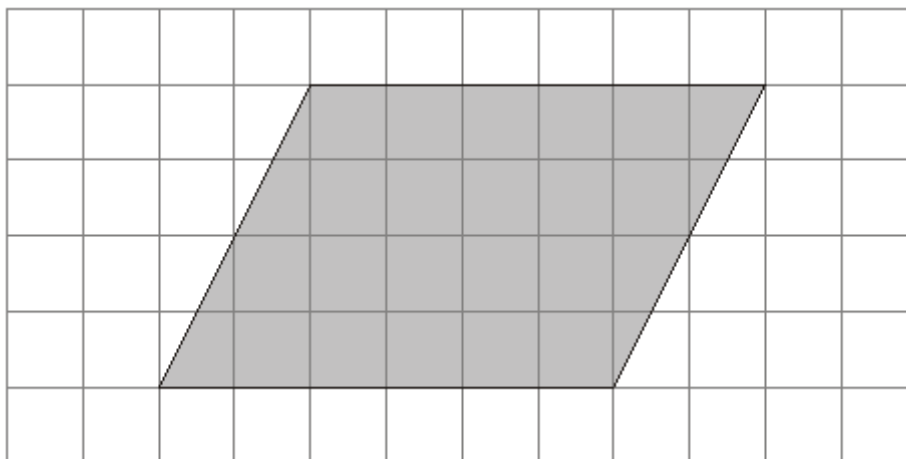

For each statement below, tick (✓) True or False.

	True	False
The shape is a quadrilateral.	<input type="checkbox"/>	<input type="checkbox"/>
The shape is a square.	<input type="checkbox"/>	<input type="checkbox"/>
The shape has one line of symmetry.	<input type="checkbox"/>	<input type="checkbox"/>
The shape has no right angles.	<input type="checkbox"/>	<input type="checkbox"/>

4 marks

23. **Balancing**

2 tins balance 1 bottle.

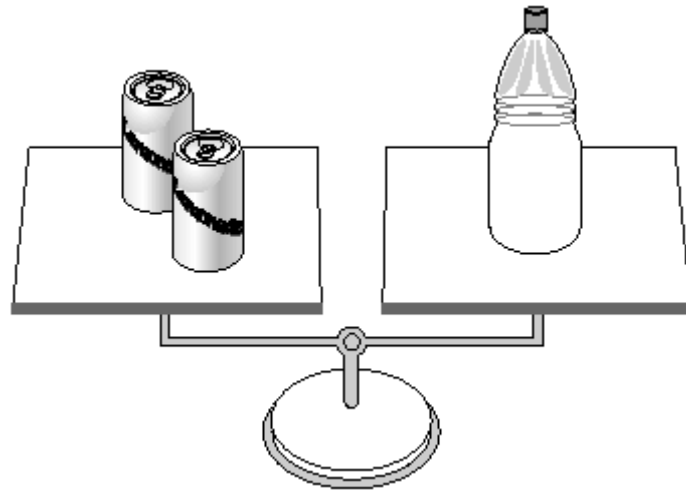

1 tin and 1 bottle balance 1 box.

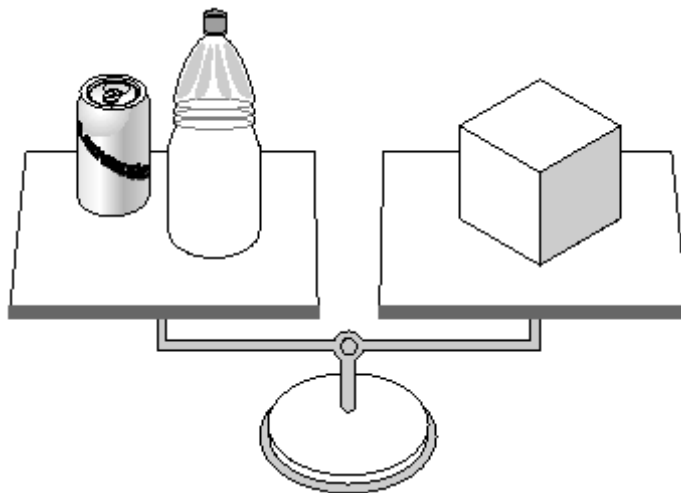

(a) How many **bottles** do **6 tins** balance?

.....

1 mark

(b) How many **boxes** do **6 tins** balance?

.....

1 mark

24. Recycling rubbish

The pie charts show what percentage of household rubbish is recycled in different countries.

Key

 % of rubbish recycled

 % of rubbish not recycled

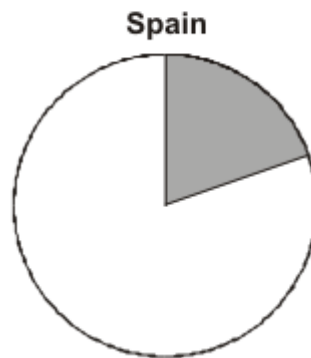
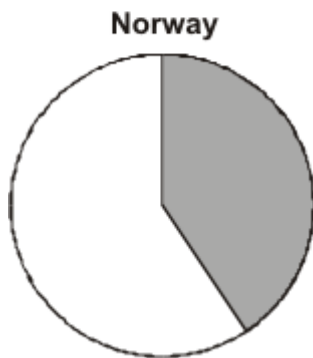
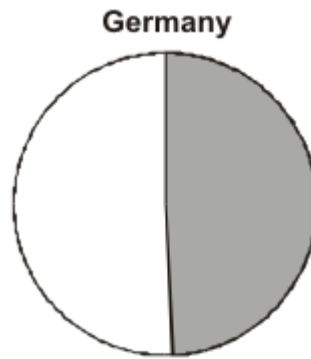

(a) In England, about what percentage of rubbish is recycled?

..... %
1 mark

(b) England wants to recycle **30%** of rubbish by the year 2010.

Which countries already recycle more than 30% of their rubbish?

.....

1 mark

25. Doughnuts

Here are the prices of doughnuts at two different shops.

Shop A	Shop B
3 doughnuts for £2	5 doughnuts for £3.50

I want to buy **15** doughnuts.

In which shop are the doughnuts **cheaper**?

You **MUST** show your working.

Tick (✓) your answer.

Shop A Shop B

2 marks

26. Count on

(a) I count on in **equal steps**.

My fourth number is 42, my fifth number is 47

What is my first number?

.....

2 marks

(b) I count on in **equal steps**.

My first number is -3, my fifth number is 5

What is my third number?

.....

2 marks

27. Making 1

(a) Join all the pairs of numbers that **add** together to equal 1

The first one is done for you.

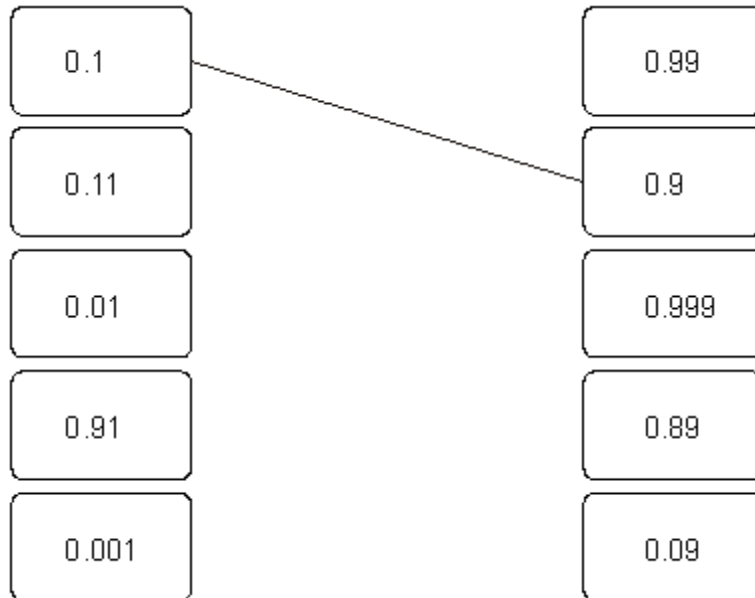

2 marks

(b) Now join all the pairs of numbers that **multiply** to equal 1

The first one is done for you.

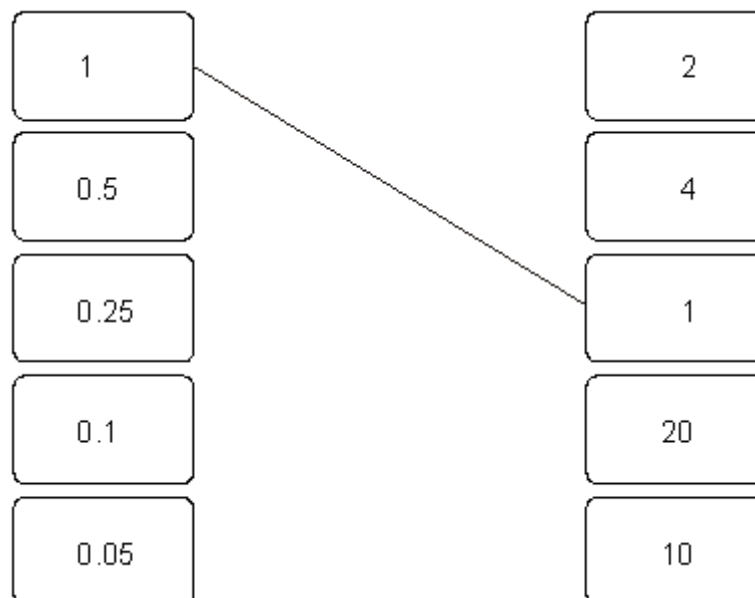

2 marks

28. Three straight lines

The diagram shows three straight lines.

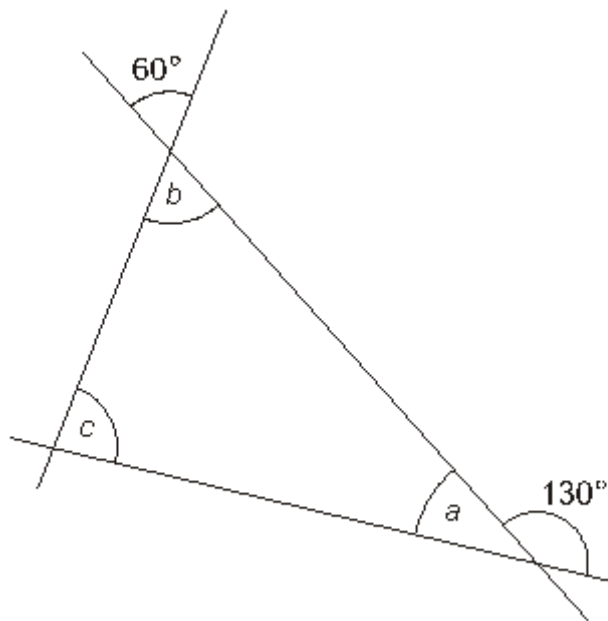

Not drawn accurately

Work out the sizes of angles a , b and c . Give reasons for your answers.

$a = \dots\dots\dots^\circ$ because

2 marks

$b = \dots\dots\dots^\circ$ because

2 marks

$c = \dots\dots\dots^\circ$ because

2 marks

29. Sequences

For each sequence below, tick (✓) the correct box to show if it is **increasing**, **decreasing** or **neither**.

				increasing	decreasing	neither
$\frac{1}{2}$	$\frac{1}{3}$	$\frac{1}{4}$	$\frac{1}{5}$	<input type="checkbox"/>	<input type="checkbox"/>	<input type="checkbox"/>
$\frac{6}{13}$	$\frac{7}{12}$	$\frac{8}{11}$	$\frac{9}{10}$	<input type="checkbox"/>	<input type="checkbox"/>	<input type="checkbox"/>
$\frac{1}{2}$	$\frac{2}{4}$	$\frac{3}{6}$	$\frac{4}{8}$	<input type="checkbox"/>	<input type="checkbox"/>	<input type="checkbox"/>
$\frac{3}{2}$	$\frac{4}{3}$	$\frac{5}{4}$	$\frac{6}{5}$	<input type="checkbox"/>	<input type="checkbox"/>	<input type="checkbox"/>

4 marks

30. Sizing

(a) Put these values in order of size with the **smallest first**.

5^2 3^2 3^3 2^4

.....

smallest largest

2 marks

(b) Look at this information.

5^5 is 3125

What is 5^6 ?

.....

2 marks

END OF QUESTION PAPER. NOW CHECK YOUR ANSWERS!